



Vehicle History Report™

2018 FORD MUSTANG

VIN: 1FA6P8TH9J5113137
 COUPE
 2.3L I4 F DOHC 16V
 GASOLINE
 REAR WHEEL DRIVE
 Original Window Sticker



Branded Title: Salvage



5 Service history records



CARFAX 1-Owner vehicle



Personal vehicle



Last owned in Arkansas



42,962 Last reported odometer reading

This CARFAX Vehicle History Report is based only on information supplied to CARFAX and available as of 1/26/23 at 11:02:18 AM (CST). Other information about this vehicle, including problems, may not have been reported to CARFAX. Use this report as one important tool, along with a vehicle inspection and test drive, to make a better decision about your next used car.



Ownership History

The number of owners is estimated

Owner 1

Year purchased

2018

Type of owner

Personal

Estimated length of ownership

4 yrs. 3 mo.

Owned in the following states/provinces

Arkansas

Estimated miles driven per year

9,928/yr

Last reported odometer reading

42,962



Title History

CARFAX guarantees the information in this section

Owner 1

Damage Brands

Salvage | Junk | Rebuilt | Fire | Flood | Hail | Lemon

Alert!
 Problem Found

Odometer Brands



Not Actual Mileage | Exceeds Mechanical Limits







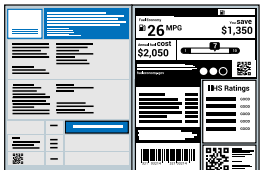





No Problem

ALERT! Severe problems were reported by a state Department of Motor Vehicles (DMV). This vehicle

 Additional History Not all accidents / issues are reported to CARFAX	Owner 1
Total Loss Total Loss Reported: 04/15/2022.	Total Loss Reported
Structural Damage CARFAX recommends that you have this vehicle inspected by a collision repair specialist.	<input checked="" type="checkbox"/> No Issues Reported
Airbag Deployment No airbag deployment reported to CARFAX.	<input checked="" type="checkbox"/> No Issues Reported
Odometer Check No indication of an odometer rollback.	<input checked="" type="checkbox"/> No Issues Indicated
Accident / Damage DMV title problems reported. Accident reported: 09/26/2020. Hail damage reported: 04/15/2022.	Severe Damage
Manufacturer Recall A current list of recalls is available at Ford Motor Company.	<input checked="" type="checkbox"/> No Recalls Reported
Basic Warranty Original manufacturer warranty likely voided by manufacturer.	Warranty Voided

 **Detailed History**

 Owner 1 Purchased: 2018	Personal Vehicle 9,928 mi/yr		
Date	Mileage	Source	Comments
11/21/2017		Ford Motor Company	Vehicle manufactured and shipped to original dealer  Original Window Sticker
12/07/2017	1	Cavanaugh Hyundai Jonesboro, AR 870-933-8070  4.8 / 5.0 48 Verified Reviews  69 Customer Favorites	Vehicle offered for sale

12/07/2017	2	Cavanaugh Ford Lincoln Jonesboro, AR 870-972-8000  4.4 / 5.0 104 Verified Reviews  100 Customer Favorites	Vehicle offered for sale
12/12/2017		Cavanaugh Ford Lincoln Jonesboro, AR 870-972-8000  4.4 / 5.0 104 Verified Reviews  100 Customer Favorites	 Vehicle serviced - Pre-delivery inspection completed
08/03/2018	10	Arkansas Motor Vehicle Dept.	Vehicle purchase reported - Titled or registered as personal vehicle
09/06/2018		Arkansas Motor Vehicle Dept. Walnut Ridge, AR Title #761009261375	Title issued or updated - First owner reported - Loan or lien reported - Vehicle color noted as Yellow
02/05/2019	4,787	Cavanaugh Auto World Walnut Ridge, AR 870-886-3561  4.9 / 5.0 42 Verified Reviews  39 Customer Favorites	 Vehicle serviced - Maintenance inspection completed - Oil and filter changed
04/25/2019	6,375	Cavanaugh Ford Lincoln Jonesboro, AR 870-972-8000  4.4 / 5.0 104 Verified Reviews  100 Customer Favorites	 Vehicle serviced - Maintenance inspection completed - Engine/powertrain computer/module checked - Engine checked - PCM reprogrammed
06/09/2020		Arkansas Motor Vehicle Dept. Walnut Ridge, AR Title #761009261375	Registration issued or renewed - Loan or lien reported - Vehicle color noted as Yellow
09/26/2020		Damage Report	 Accident reported: minor damage - Vehicle involved in a front end collision with another motor vehicle - Damage to front - Damage to left front - Airbags did not deploy

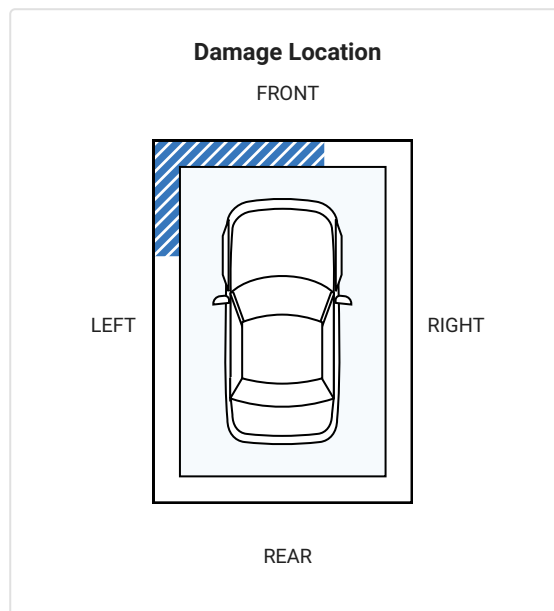
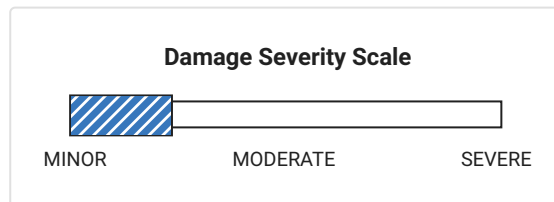

03/02/2021 20,034

Cavanaugh Auto World
Walnut Ridge, AR
870-886-3561

★ 4.9 / 5.0

42 Verified Reviews

♥ 39 Customer Favorites



Vehicle serviced

- Maintenance inspection completed
- Oil and filter changed

11/04/2021

Arkansas
Motor Vehicle Dept.
Walnut Ridge, AR
Title #761009261375

Registration issued or renewed

- Loan or lien reported
- Vehicle color noted as Yellow

04/15/2022

Damage Report



TOTAL LOSS VEHICLE

- Vehicle declared a total loss by an insurance company
- Non-collision damage reported
- Hail damage reported
- Damage to rear

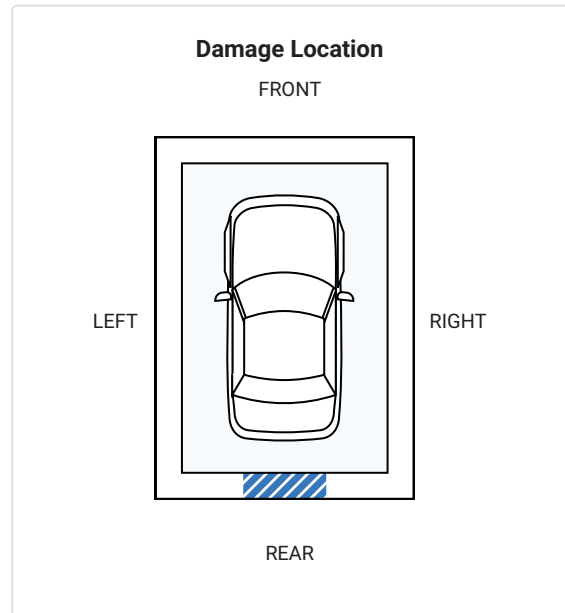

There are many reasons an insurance company will declare a vehicle a total loss. Have this vehicle inspected by a qualified technician before you buy. [Learn More](#)

05/13/2022	33,197	Cavanaugh Auto World Walnut Ridge, AR 870-886-3561		Vehicle serviced - Maintenance inspection completed - Oil and filter changed
		★ 4.9 / 5.0 42 Verified Reviews ♥ 39 Customer Favorites		
07/06/2022	Arkansas Motor Vehicle Dept. Walnut Ridge, AR Title #761009261375		Registration issued or renewed - Loan or lien reported - Vehicle color noted as Yellow	
11/29/2022	Arkansas Motor Vehicle Dept.		Title or registration issued to insurance company	
11/29/2022	42,962	Arkansas Motor Vehicle Dept. Scott, AR Title #761013660770		Vehicle purchase reported - SALVAGE TITLE/CERTIFICATE ISSUED - Vehicle color noted as Yellow

Have Questions? Please visit our Help Center at www.carfax.com.



Glossary

Accident Indicator

CARFAX receives information about accidents in all 50 states, the District of Columbia and Canada.

Not every accident is reported to CARFAX. As details about the accident become available, those additional details are added to the CARFAX Vehicle History Report. CARFAX recommends that you have this vehicle inspected by a qualified mechanic.

- According to the National Safety Council, Injury Facts, 2021 edition, 5% of the 276 million registered vehicles in the U.S. were involved in an accident in 2019. Over 77% of these were considered minor or moderate.
- This CARFAX Vehicle History Report is based only on information supplied to CARFAX and available as of 1/26/23 at 11:02:18 AM (CST). Other information about this vehicle, including problems, may not have been reported to CARFAX. Use this report as one important tool, along with a vehicle inspection and test drive, to make a better decision about your next used car.

Damage Indicator

Damage can be a result of many different types of events. Examples include contact with objects (other cars, trees, traffic signs, road debris, etc), vandalism, or weather-related events. Not every damage event is reported to CARFAX. As details about the damage event become available, those additional details are added to the CARFAX Vehicle History Report. CARFAX recommends that you have this vehicle inspected by a qualified mechanic.

- This CARFAX Vehicle History Report is based only on information supplied to CARFAX and available as of 1/26/23 at 11:02:18 AM (CST). Other information about this vehicle, including problems, may not have been reported to CARFAX. Use this report as one important tool, along with a vehicle inspection and test drive, to make a better decision about your next used car.

Damage Severity

Damage events result in one of the following severity levels:

- Minor: Generally, minor damage is cosmetic (including dents or scratches), may only require reconditioning, and typically does not compromise a vehicle's operation and/or safety.
- Moderate: Moderate damage may affect multiple components of the vehicle and may impair the vehicle's operation and/or safety.
- Severe: Severe damage usually affects multiple components of the vehicle and is likely to compromise the vehicle's operation and/or safety.

CARFAX recommends getting a pre-purchase inspection at a certified collision repair facility.

First Owner

When the first owner(s) obtains a title from a Department of Motor Vehicles as proof of ownership.

Ford or Lincoln Mercury Recall

The Ford Motor Company provides CARFAX with Field Service Action and recall information regarding safety, compliance and emissions programs announced since 2000 for a specific vehicle. For complete information regarding programs or concerns about this vehicle, please contact a local Ford or Lincoln Mercury Dealer.

Ownership History

CARFAX defines an owner as an individual or business that possesses and uses a vehicle. Not all title transactions represent changes in ownership. To provide estimated number of owners, CARFAX proprietary technology analyzes all the events in a vehicle history. Estimated ownership is available for vehicles manufactured after 1991 and titled solely in the US including Puerto Rico. Dealers sometimes opt to take ownership of a vehicle and are required to in the following states: Maine, Massachusetts, New Jersey, Ohio, Oklahoma, Pennsylvania and South Dakota. Please consider this as you review a vehicle's estimated ownership history.

Salvage Title



A Salvage Title is issued on a vehicle damaged to the extent that the cost of repairing the vehicle exceeds approximately 75% of its pre-damage value. This damage threshold may vary by state. Some states treat Junk titles the same as Salvage but the majority use this title to indicate that a vehicle is not road worthy and cannot be titled again in that state. The following eleven states also use Salvage titles to identify stolen vehicles - AZ, FL, GA, IL, MD, MN, NJ, NM, NY, OK and OR.

Title Issued

A state issues a title to provide a vehicle owner with proof of ownership. Each title has a unique number. Each title or registration record on a CARFAX report does not necessarily indicate a change in ownership. In Canada, a registration and bill of sale are used as proof of ownership.

Total Loss Vehicle

An insurance or fleet company declares a vehicle a total loss when a claim exceeds approximately 75% of its pre-damage value or if the vehicle is stolen and not recovered. This damage threshold varies by company. These companies typically take possession and obtain the title. Not all total loss vehicles result in a DMV-reported branded title. This may occur when an insurance company's definition of a total loss is different than the state DMV's definition for a branded title or when the owner of the vehicle is a self-insured company, like a fleet or rental company.

Follow Us:  facebook.com/CARFAX  [@CARFAXinc](https://twitter.com/CARFAXinc)  [About CARFAX](#)

CARFAX DEPENDS ON ITS SOURCES FOR THE ACCURACY AND RELIABILITY OF ITS INFORMATION. THEREFORE, NO RESPONSIBILITY IS ASSUMED BY CARFAX OR ITS AGENTS FOR ERRORS OR OMISSIONS IN THIS REPORT. CARFAX FURTHER EXPRESSLY DISCLAIMS ALL WARRANTIES, EXPRESS OR IMPLIED, INCLUDING ANY IMPLIED WARRANTIES OF MERCHANTABILITY OR FITNESS FOR A PARTICULAR PURPOSE.

© 2023 CARFAX, Inc., part of S&P Global. All rights reserved.
1/26/23 11:02:18 AM (CST)